

Installer's Manual

Split System (R-410A)

*Up to 27 SEER Inverter System
9,000 to 24,000 BTU/Hr*



R-410A, 60Hz

Single Split
Heat pump

Indoor Unit
4MXW27-A

Outdoor Unit
4TXK27-A

June 2014

MS-SVN41A-EN

Warnings and Cautions

Warnings and Cautions. Notice that warnings and cautions appear at appropriate intervals throughout this manual. Warnings are provided to alert installing contractors to potential hazards that could result in personal injury or death, while cautions are designed to alert personnel to conditions that could result in equipment damage.

Your personal safety and the proper operation of this machine depend upon the strict observance of these precautions.

Attention: Warnings and Cautions appear at appropriate sections throughout this literature. Read these carefully.

 **WARNING:** Indicates a potentially hazardous situation which, if not avoided, could result in death or serious injury.

 **CAUTION:** Indicates a potentially hazardous situation which, if not avoided, could result in minor or moderate injury. It may also be used to alert against unsafe practices.

NOTICE: Indicates a situation that could result in equipment or property-damage only accidents.

WARNING

This equipment is to be serviced by professionally trained personnel **ONLY**. Under **NO** circumstances should an unqualified person service it. This equipment contains refrigerant under **PRESSURE** and operates at **HIGH VOLTAGE**. Improperly installed, adjusted or altered equipment by an unqualified person poses safety hazards including **FIRE, ELECTROCUTION, or EXPLOSION**, which could result in death or serious injury.

WARNING

Electrocution and Fire Hazards with Improperly Installed and Grounded Field Wiring!

Improperly installed and grounded field wiring poses **FIRE & ELECTROCUTION** hazards. To avoid these hazards, you **MUST** follow requirements for field wiring installation and grounding as described in the National Electrical Codes (NEC) and your local/state electrical codes. All field wiring **MUST** be performed by qualified personnel.

Failure to follow these requirements could result in death or serious injury.

Preface

WARNING

R410A Refrigerant under Higher Pressure than R22!

The units described in this manual use R410A refrigerant which operates at 50 to 70% higher pressures than R-22. Use only R-410A approved service equipment. Refrigerant cylinders are painted with "pink" color to indicate the type of refrigerant and may contain a "dip" tube to allow for charging of liquid refrigerant into the system. For specific handling concerns with R-410A, please contact your local sales office.

Failure to use R-410A approved service equipment could result in standard equipment exploding under R-410A higher pressure which could result in death or serious injury.

NOTICE

Use PVE Oil with R-410A Mini-Split Units!

All R-410A mini-splits use a PVE oil (Polyvinyl Ether Oil) that readily absorbs moisture from the atmosphere. To limit this "hygroscopic" action, the system should remain sealed whenever possible. Never break a vacuum with air and always change the driers when opening the system for component replacement. For specific handling concerns with PVE oil, contact your local sales office.

USE ONLY THE FACTORY RECOMMENDED - DAFNE HERMETIC OIL FV50S - for servicing these units.

Important!

Environmental Concerns

Scientific research has shown that certain man-made chemicals can affect the earth's naturally occurring stratospheric ozone layer when released to the atmosphere. In particular, several of the identified chemicals that may affect the ozone layer are refrigerants that contain Chlorine, Fluorine and Carbon (CFCs) and those containing Hydrogen, Chlorine, Fluorine and Carbon (HCFCs). Not all refrigerants containing these compounds have the same potential impact to the environment. Advocates the responsible handling of all refrigerants—including industry replacements for CFCs such as HCFCs and HFCs.

Responsible Refrigerant Practices

The manufacturer believes that responsible refrigerant practices are important to the environment our customers, and the air conditioning industry. All technicians who handle refrigerants must be certified. The Federal Clean Air Act (Section 608) sets forth the requirements for handling, reclaiming, recovering and recycling of certain refrigerants and the equipment that is used in these service procedures. In addition, some states or municipalities may have additional requirements that must also be adhered to for responsible management of refrigerants. Know the applicable laws and follow them.

Contents

General Information	5
Accessories	6
Typical Installation	7
Installation Location	8
Indoor Unit	8
Outdoor unit	8
Installation	9
Indoor Unit Installation	9
Installing Outdoor Unit	13
Vacuum Pump and Leak Inspection	14
Outdoor condensation drainage (Heat pump type only)	15
Operating Function	16
Connection Pipe	22
Wiring Diagrams	23
High Efficiency 60 Hz models	23

General Information

This Installation Manual is given as a guide to good practices in the installation and operation of a wall mounted split system models 4MXW27 and 4TXK27. However it does not contain all the service procedures for this unit, as these procedures must be performed by a qualified service technician, through the maintenance contract with a reputable service company.

Read these operation Instructions completely before installing the unit.

Reception

On arrival, inspect the unit before signing the delivery note. Specify any damage of the unit on the delivery note, and send a registered letter of protest to the last carrier of the goods within 72 hours of delivery. Notify your supplier at the same time.

The unit should be totally inspected within 7 days of delivery. If any concealed damage is discovered, send a registered letter of protest to the carrier within 7 days of delivery and notify the local supplier.

About the Unit

These units are assembled, pressure tested, dehydrated, charged and run tested before shipment. This manual contains informations related to 4MXW27 and 4TXK27.

Refrigerant











The refrigerant provided by the manufacturer comply with all the requirements for our units. When using a recycled or reprocessed refrigerant, we recommend its qualities be as good as those of a new refrigerant. It is necessary to have the refrigerant tested by a qualified laboratory. Failure to do so could void the warranty.

Important

These instructions do not cover all variations in systems, nor do they provide for every possible contingency to be met in connection with installation. Should further information be desired or should particular problems arise which are not covered sufficiently in this manual, the matter should be referred to your local sales office.

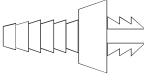
Accessories

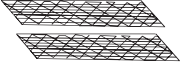
Table 1. Parts list

No.	Part Name	Diagram	Qty	Specification	Memo
1	Mounting plate		1		
2	Wireless remote controller		1		Sold Separately
3	Remote controller holder		1		
4	Battery		2	AAA, 1.5V	
5	Tapping screw		10	ST4.2 X 25	For mounting plate
6	Drain hose		1	L = 6 ft.	
7	Thermal insulation		1		
8	Drain kit		1		Heat pump type only
9	Drain hole cover		3		Heat pump type only
10	Active air filters		2		One active carbon filter One catechin filter
11	Air filter		2		Washable plastic filters
12	Wired controller		1		Sold Separately

Typical Installation

Names and functions of each part

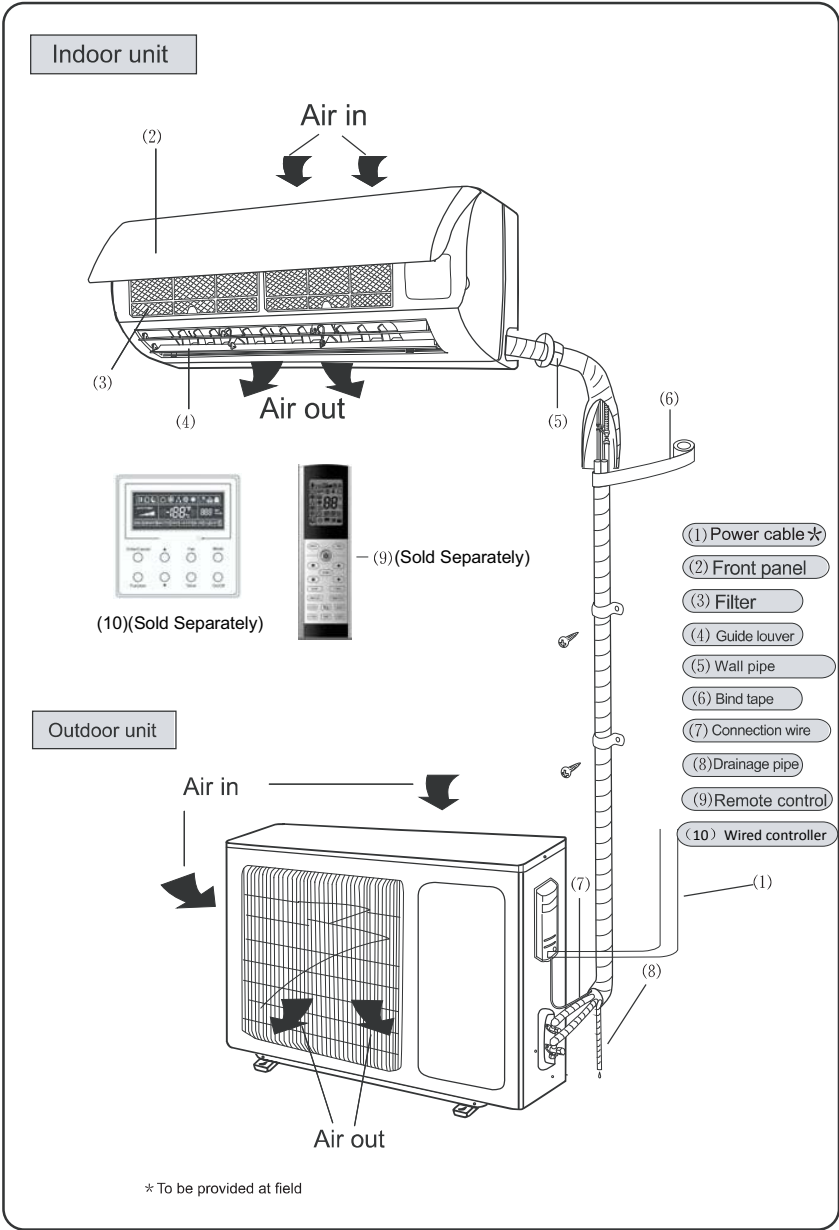

Installation Location

Indoor Unit

WARNING

Adequate Support!

Wall structure must be adequate to support the weight of the unit. Failure to ensure adequate structural support could result in unit falling from its location which could result in death, serious injury, or equipment or property-only damage.

1. Avoid locating the indoor unit where the return and/or supply air may be obstructed
2. Select a location where it is easy to drain the condensing water and connect to the outdoor unit;
3. Keep the indoor unit far away from heat sources, vapor and flammable gas;
4. Be sure that the installation of the indoor unit conforms to the installation dimension diagram;
5. Be sure to leave enough space to allow access for routine maintenance; clearance between the bottom of the indoor unit and the floor should not be less than 66".
6. Install in a location where the unit is more than 3 feet away from other electric appliances such as television, audio devices etc.;
7. Select location where air filters can be easily removed

Outdoor unit

WARNING

Adequate Support!

Wall structure must be adequate to support the weight of the unit. Failure to ensure adequate structural support could result in unit falling from its location which could result in death, serious injury, or equipment or property-only damage.

1. Select a location from which noise and air discharge by unit will not annoy neighbors.
2. Select a location where there is sufficient ventilation.
3. Make sure the air inlet and outlet are not blocked by any obstacles.
4. Select a location capable of supporting the weight and vibration of the outdoor unit, and where installation work can be carried out safely.
5. Select a location away from flammable gas or gas leaks.
6. Make sure that the installation of the outdoor unit conforms to the installation dimension diagram.
7. Locate the outdoor unit away from any bedroom windows.

NOTICE

Installing the unit in one of the following locations could result in unit malfunction:

- Places where oil (machine oil) is used
- Seaside/places with high level of salt in the air.
- Places with high level of sulfur gas such as areas with hot springs.
- Places where high-frequency waves are generated by radio equipment, welders and medical equipment.
- Other unusual places where unit operation may be altered.

Installation Dimension Diagram

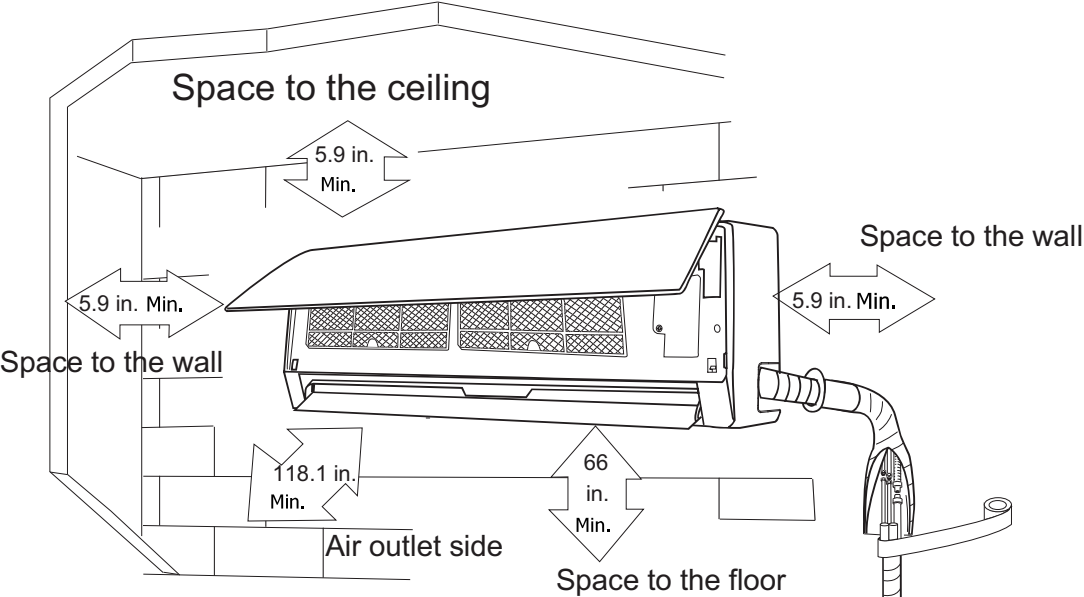

- The dimensions of the space necessary for correct installation of the appliance including the minimum permissible distances to adjacent structures

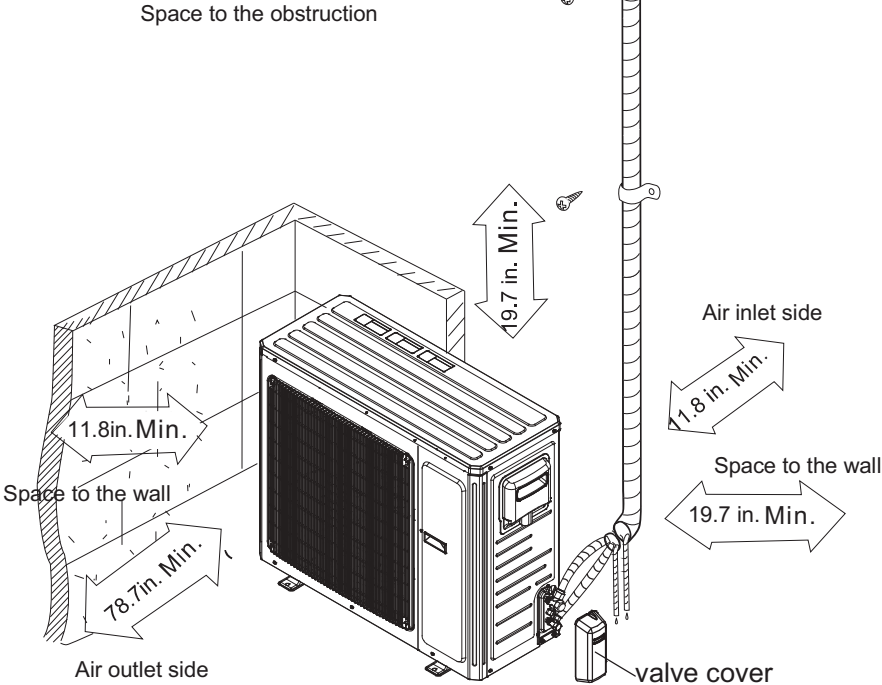

Schematic diagram being reference only (outdoor unit is with variation), please refer to real product for authentic information.

Installation

Indoor Unit Installation

WARNING

Hazardous Service Procedures!

The maintenance and troubleshooting procedures recommended in this section of the manual could result in exposure to electrical, mechanical or other potential safety hazards. Always refer to the safety warnings provided throughout this manual concerning these procedures. When possible, disconnect all electrical power including remote disconnect and discharge all energy storing devices such as capacitors before servicing. Follow proper lockout/tagout procedures to ensure the power can not be inadvertently energized. When necessary to work with live electrical components, have a qualified licensed electrician or other individual who has been trained in handling live electrical components perform these tasks. Failure to follow all of the recommended safety warnings provided, could result in death or serious injury.

Mounting Location

1. Always mount the rear panel horizontally.
2. Fix the rear panel on the selected location
3. Be sure that the rear panel has been fixed firmly enough to withstand the weight 140 lbs, furthermore, the weight should be evenly shared by each screw.

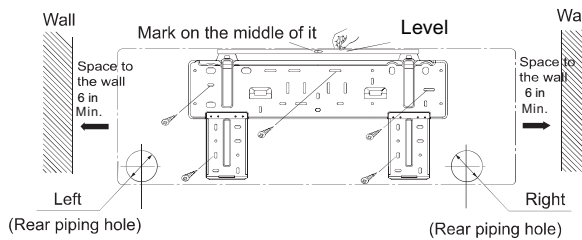

Drilling a hole in the wall to install the piping

The piping can be connected in six different locations on the unit, as shown on figure below:

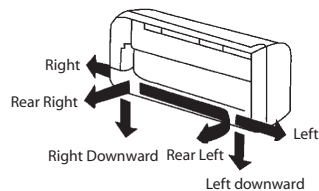

1. Drill a 2 1/2 inch diameter hole in the wall at a slight downward angle toward the outdoor side in such a way that the end of the pipe outside is 1/4 inch lower than the inside.
2. Insert a sleeve into the hole to prevent the connection piping and wiring from being damaged when passing through the hole.

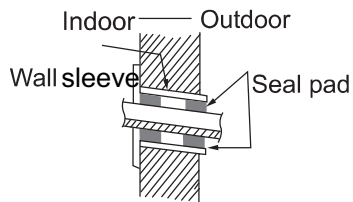

NOTICE

When a wall sleeve is not used, it is then necessary to drill a straight hole in the wall. If the hole is not straight and uniform, this could result in water leaking from condensation, resulting in property damage.

NOTICE

If a wall sleeve is not mounted in the wall, the wiring between the indoor unit and the outdoor unit can possibly be damaged resulting in electrical current loss in the ground wiring.

Installing the water drain pipe

NOTICE

Do not wrench or bend the drain hose and make sure the ends of the drain pipe are not under water. Failure to do so could result in leakage.

1. To ensure proper water drainage, the drain hose should be placed at a downward slant.
2. The water drain pipe must be insulated throughout the house.

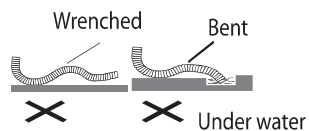

Installing the unit

Note: The piping can be lead out from right, right rear, left, left rear.

1. When routing the piping and wiring from the left or right side of indoor unit, cut off the tailings from the chassis in necessary.
 - (1).Cut off the tailings 1 when routing the wiring only;
 - (2).Cut off the tailings 1 and tailings 2 when routing both the wiring and piping.(or 1,2,3)

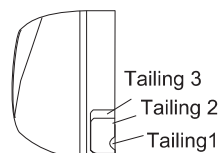

2. Take out the piping from body case, wrap the piping electric wire, water pipe with tape and put them through the piping hole.

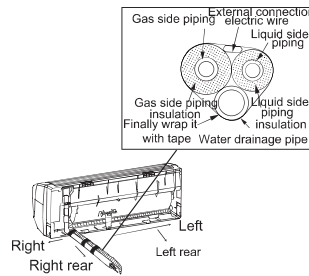

3. Hang the mounting slots of the indoor unit on the upper tabs of the rear panel and check if it is firm enough.



Installing the connection pipe

1. Align the center of the piping flare with the relevant valve.

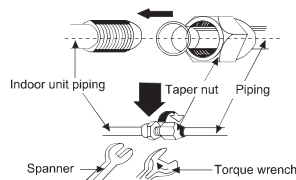

2. Screw in the flare nut by hand and then tighten the nut with spanner and torque wrench refer to the following.

Table 2. Tightening Torque Table

Hex nut Diameter	Tightening torque (lbf-inch)
6mm - 1/4"	133-177
9.5mm - 3/8"	274-310
12mm - 1/2"	443-487
16mm - 5/8"	531-575

Note: First, connect the connection pipe to indoor unit, then to outdoor unit; pay attention to the piping bending, do not damage the connection pipe; to avoid leakage, do not over tighten the joint nut

Recommended wire size

Models which power supplied from ODU to IDU (In this IOM are specific to all 60Hz models)

Wire Type	09K	12K	18K	24K
Wires between IDU and ODU	AWG14	AWG14	AWG14	AWG14

WARNING

Electrocution and Fire Hazards with Improperly Installed and Grounded Field Wiring!

Improperly installed and grounded field wiring poses **FIRE & ELECTROCUTION** hazards. To avoid these hazards, you **MUST** follow requirements for field wiring installation and grounding as described in the National Electrical Codes (NEC) and your local/state electrical codes. All field wiring **MUST** be performed by qualified personnel. Failure to follow these requirements could result in death or serious injury.

Note: Always refer to unit ID tag for additional information on Minimum Circuit Ampacity (MCA) and Maximum Overload Protection (MOP).

WARNING

Hazardous Voltage!

Disconnect all electric power, including remote disconnects before servicing. Follow proper lockout/tagout procedures to ensure the power can not be inadvertently energized. Failure to disconnect power before servicing could result in death or serious injury.

1. Open the front panel of the indoor unit by lifting upward.
2. Unscrew and remove the cover plate.
3. Pull the power connection cable through the back of the indoor unit.
4. Firmly attach the power connection cables to the terminal block in the indoor unit, making certain to observe the proper terminal connections as shown on the unit wiring diagram.
5. Reattach the cover plate with the proper screws.
6. The electric wire must be tighten with the wire clip. And for the heat pump unit, the signal control wire must be connected to the terminal board with the wire clip.

Installing Outdoor Unit

Wiring

WARNING

Hazardous Voltage!

Disconnect all electric power, including remote disconnects before servicing. Follow proper lockout/tagout procedures to ensure the power can not be inadvertently energized. Failure to disconnect power before servicing could result in death or serious injury.

1. Disassemble handle of right side plate or front side plate of outdoor unit.
2. Take off wire clamp, connect and attach power wiring cord to terminal block. Wiring should match that of the indoor unit.
3. Attach the power wiring cord with wire clamp, for cooling and heating unit, then use the wire clamp to attach the signal control wire, then connect the corresponding connector.
4. Ensure if wire has been attached well.
5. Install handle or front side plate.

Note: Incorrect wiring may cause system damage or malfunction

Note: After attaching the cable, make certain there is adequate space between the connection and the strain relief

Vacuum Pump and Leak Inspection

WARNING

Hazard of Explosion!

Never use an open flame to detect gas leaks. Explosive conditions may occur. Use a leak test solution or other approved methods for leak testing. Failure to follow recommended safe leak test procedures could result in death or serious injury or equipment or property-only-damage.

WARNING

Hazard of Explosion!

Use only dry nitrogen with a pressure regulator for pressurizing unit. Do not use acetylene, oxygen or compressed air or mixtures containing them for pressure testing. Do not use mixtures of a hydrogen containing refrigerant and air above atmospheric pressure for pressure testing as they may become flammable and could result in an explosion. Refrigerant, when used as a trace gas should only be mixed with dry nitrogen for pressurizing units. Failure to follow these recommendations could result in death or serious injury or equipment or property damage.

After the installation of refrigerant lines to both the outdoor and indoor units are completed, the flare connections must be checked for leaks. Pressurize through the service valve ports, the indoor unit and field refrigerant lines with dry nitrogen to 150 psi. Use soap bubbles or other leak-checking methods to see that all flares are leak-free! If not, release pressure; then repair!

SYSTEM EVACUATION

Note: *Since the outdoor unit has a refrigerant charge, the gas and liquid line valves must remain closed.*

1. Upon completion of leak check, evacuate the refrigerant lines and indoor coil before opening the gas and liquid line valves.
2. Attach appropriate hoses from manifold gauge to gas and liquid line pressure taps.
3. Attach center hose of manifold gauges to vacuum pump.
4. Evacuate until the micron gauge reads no higher than 350 microns.
5. Close off valve to vacuum pump and observe the micron gauge. If gauge pressure rises above 500 microns in one (1) minute, then evacuation is incomplete or system has a leak.
6. If vacuum gauge does not rise above 500 microns in one (1) minute, the evacuation should be complete.
7. Blank off vacuum pump and micron gauge, close valves on manifold gauge set.

Note: *DO NOT VENT REFRIGERANT INTO THE ATMOSPHERE.*

8. The liquid line shut-off valve can now be opened. Remove shut-off-valve cap. Fully insert hex wrench into the stem and backout counterclockwise open.

Figure 1. Vacuum Pump and Leak inspection

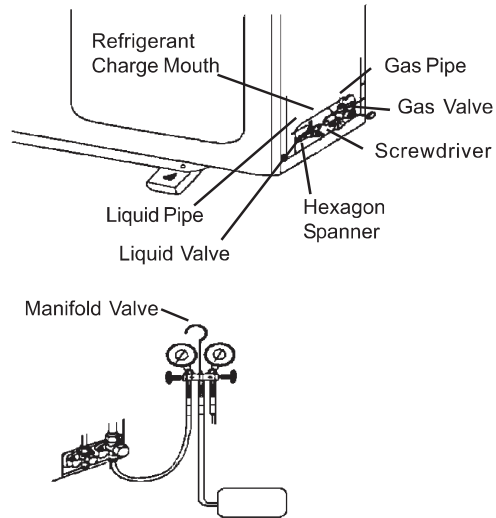

Gauges must be R410A rated

9. The gas valve can now be opened. Open the gas valve by removing the shut-off valve cap and turning the valve stem 1/4 turn counterclockwise using 1/4" Open End or Adjustable wrench.
10. The gas valve is now open for refrigerant flow. If refrigerant lines are longer than twenty five ft it will be necessary to adjust system refrigerant charge upon completion of installation.

Outdoor condensation drainage (Heat pump type only)

When the unit is heating, the condensing water and defrosting water can be drained out reliably through the drain hose.

Installation:

Install the outdoor drain kit in a hole 1 inch on the base plate, and joint the drain hose to the kit, so that the wastewater formed in the outdoor unit can be drained out to the proper place.

In applications where the system may be operating in heating mode during ambient conditions near or below freezing, consider wrapping the drain line with heat tape or equivalent to prevent the drain line from freezing during defrost operation.

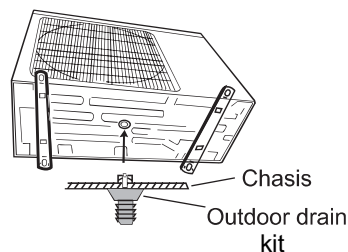

Operating Functions

Operation of remote controller

Temperature parameters

- Room set temperature (T set)
- Room ambient temperature (T amb)

Fundamental functions

After powered on, no matter when the compressor is started, the time interval between two startups cannot be less than 3 minutes.

COOL mode

The condition and process of cooling

- If T amb is equal or greater than T set, COOL mode will act, the compressor and outdoor fan will run, and the indoor fan will run at the set speed.
- If T amb is equal or less than T set -2 °F, the compressor will stop, the outdoor fan will delay 30 seconds to stop, and the indoor fan will run at the set speed.
- If T set -2 °F < T amb < T set, the unit will keep running in the previous mode.

In this mode, the reversal valve will not be powered on and the temperature setting range is 61°F ~ 86°F

The unit will adjust the running frequency of the compressor automatically according to the change of ambient temperature.

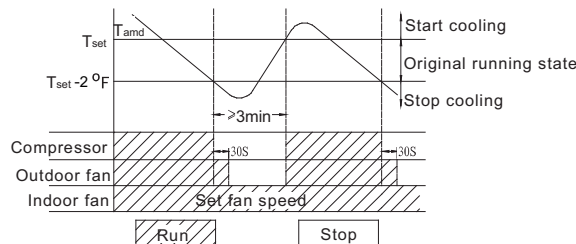

Protection function

- Antifreezing protection

Under cooling and drying mode, after the compressor run about 10 mins, when the pipe temp. of the evaporator is to low, the compressor will stop, the outdoor fan will stop after 30s, under cooling mode the indoor fan and swing motor will keep running in the original mode, under drying mode the indoor fan will run at low fan speed, the swing motor will run in the original mode. When antifreezing protection is eliminated and the compressor has stopped for 3 minutes, the unit will resume running in the original mode.

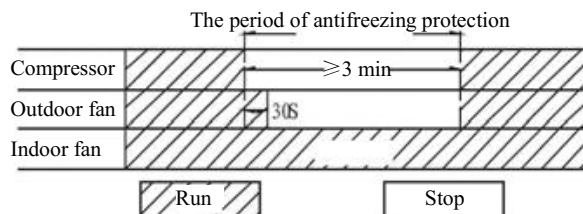

Overcurrent protection

If total current is high, the compressor will run in limited or dropped frequency. When total current goes on rising over the stated value, the compressor will stop, the outdoor fan will delay 30 seconds to stop.

DRY mode

The condition and process of drying

- If $T_{amb} > T_{set}$, DRY mode will act, the indoor fan, outdoor fan and compressor will run, and indoor fan will run at low speed.
- If $T_{set} - 2^{\circ}\text{F} < T_{amb} < T_{set}$ the unit will keep running in the original mode.
- If $T_{amb} < T_{set} - 2^{\circ}\text{F}$ the compressor will stop running, the outdoor fan will delay 30 seconds to stop and the indoor fan will run at low speed.

In this mode, the reversal valve will not be powered on and the temperature setting range is $61^{\circ}\text{F} \sim 86^{\circ}\text{F}$.

The unit will adjust the running frequency of the compressor automatically according to the change of ambient temperature.

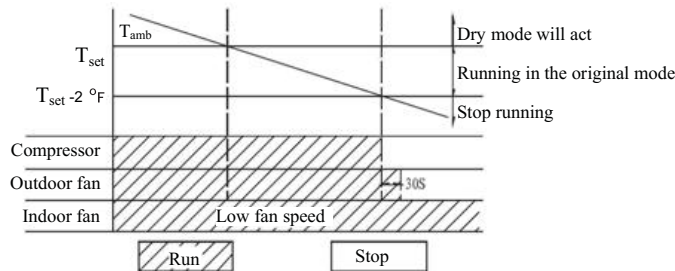

Protection

Protection is the same with that in COOL mode.

HEAT mode

The condition and process of heating

- If T_{amb} is equal or less than $T_{set} + 2^{\circ}\text{F}$ HEAT mode will act, the compressor, outdoor fan and 4-way valve will run simultaneously, the indoor fan will delay at most for 2min to run.
- If $T_{set} + 2^{\circ}\text{F} < T_{amb} < T_{set} + 9^{\circ}\text{F}$, the unit will keep running in the original mode.
- If $T_{amb} > T_{set} + 9^{\circ}\text{F}$, the compressor will stop, the outdoor fan will delay 30 sec to stop and the indoor fan will blow for 60 sec at the original speed and then stop.

In this mode, the temperature setting range is $61^{\circ}\text{F} \sim 86^{\circ}\text{F}$.

The air conditioner will adjust the running frequency of the compressor automatically according to the change of ambient temperature.

When the unit is turned off in HEAT mode, or switched to other mode from HEAT mode, the four-way valve will be powered off 2min later after the compressor stops.

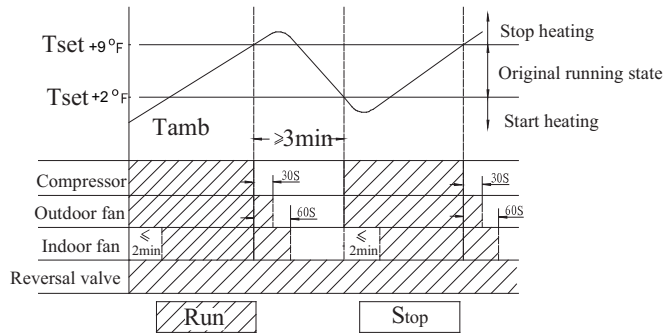

The condition and process of defrosting

When frost is detected in the condenser, the system will enter into defrosting state. When defrosting starts, the compressor and indoor fan will stop, and the outdoor fan and four-way valve will delay 30 seconds to stop. The compressor will start again after 30 seconds and when the compressor has run for 8mins, the compressor will stop.

After 30 seconds the four-way valve opens and after another 60 seconds, the compressor and outdoor fan resume running. The indoor fan will delay 2 minutes to run at the latest and temperature on the display panel shows H1.

Under heating mode, when the compressor is stopped by malfunction, the indoor fan will blow at low fan speed for 60s and then stop.

Protection

- Overcurrent protection

If total current is high, the compressor will run in limited or dropped frequency. When total current go on rising over the stated value, the compressor will stop, the outdoor fan will delay 30 seconds to stop.

FAN mode

In this mode, the indoor fan will run the fan in High, Med, Low and Auto mode. The compressor, outdoor fan and four-way valve will stop.

In this mode, the temperature setting range is 61 F~86 F.

The unit will adjust the running frequency of the compressor automatically according to the change of ambient temperature.

AUTO mode

In this mode, the system selects COOL, HEAT and FAN mode automatically according to the change of ambient temperature. The protection function is the same with that of COOL/HEAT mode.

The unit will adjust the running frequency of the compressor automatically according to the change of ambient temperature.

Other control

ON / OFF

Each time the On/Off button of the remote controller is pressed, the On/Off state will switch once.

MODE selection

Press the MODE button on the remote controller to select and display the following modes: AUTO, COOL, DRY, FAN, and HEAT.

TEMP. setting button

Each time TEMP + or TEMP - button is pressed, the set temperature will be increased or decreased by 2°F.

Adjusting range is 61°F~86°F . In AUTO mode, this button does not function.

AUTO key

When the unit stops, press AUTO key, the unit will run under AUTO mode and the swing motor starts.

When the unit is running, press AUTO key, the unit will be stopped.

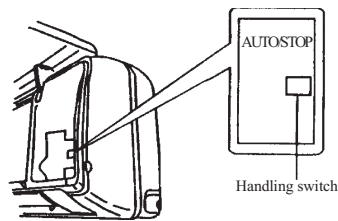

increased by another 33.8°F

Timer control

The unit is turned on or off according to the timer set by the remote controller.

Sleep control

When the air conditioner is in COOL or DRY mode, after Sleep mode has been set properly, the preset Tset will be increased by +2°F after the sleep program has run for 1 hour, and Tset will be increased by another +2°F after 2 hours. Tset has been increased by +4°F total in two hours. Then the unit will run at this set temperature and at the set speed.

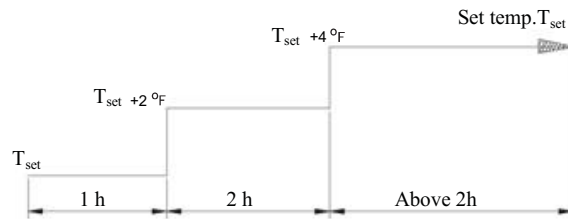

When the air conditioner is in HEAT mode, after Sleep mode has been set properly, the preset Tset will be decreased by +2°F after the sleep program has run for 1 hour, and Tset will be decreased by another +2°F after 2 hours. Tset has been increased by +4°F totally in two hours. Then the unit will run at this set temperature and at the set speed.

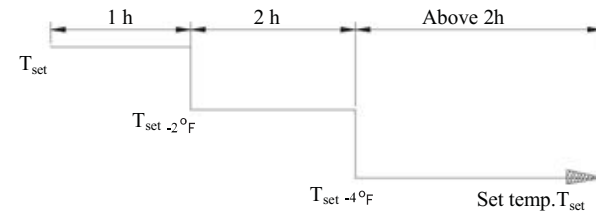

In AUTO or FAN mode, the setting temp. will not change.

Indoor fan control

Use the remote controller to set the indoor fan running at TURBO, HIGH, MED-HIGH, MED, MED-LOW, LOW or QUIET speed. At this time the fan will run at the selected speed. It can also be set to AUTO and the indoor fan will select fan speed(TURBO, HIGH, MED-HIGH, MED, MED-LOW, LOW or QUIET) automatically according to ambient temperature.

There are at least 3 mins and 30s delay for fan speed shift.

Power supply for outdoor unit

The power supply for outdoor unit is turned on in AUTO, COOL, HEAT and DRY mode under turn-on state.

The power supply for outdoor unit will delay 3 minutes to turn off under turn-off state or in the FAN mode under turn-on state.

Swing control

Use the SWING button of the wireless remote control to control SWING On and Off. Swing will only act when indoor fan is running. After power on, the swing motor turns back to 0 position and closes the air outlet vent; if it does not preset swing, after the unit is turned on, it will turn to the max. air outlet D1 position; then turn back to L position under COOL mode. Under HEAT mode, the guide louver stays at D1; when in swinging state, it will swing between L1 and D1 position. When the unit is turned off, it will turn back to 0 position.

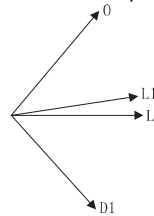

Buzzer control

When the unit is power on or receives remote control signal or the auto key be pressed, the buzzer will give out a beep.

Power-off memory function

Contents of memory: Mode; Swing; Set fan speed, Set temperature, Timing etc.

Under turn-on state, when power off and power on, the power supply for outdoor unit will be turn on after 3 mins.

Under turn-off state, when power off and power on, the power supply for outdoor unit will be turn on immediately.

Delay Protection of Compressor

Under COOL; DRY; HEAT mode, before each time the compressor starts, there will be 3 mins delay.

Common protection function in each mode

Overload protection

Ttube: at cooling, it detects the temp. of outdoor heat exchanger, at heating, it detects the temp. of indoor heat exchanger.

When Ttube is detected high, the compressor will run in limited frequency. When Ttube goes on rising over the stated value, the compressor will stop; under AUTO HEAT or HEAT mode, indoor fan will blow 60s at low fan speed and then stop; under other mode, the indoor fan will run at set speed.

Compressor discharge temperature protection

When discharge temperature is too high over the stated value, the compressor will stop, and
When discharge temp. resume normal and the compressor has stopped for 3 minutes, the unit will
resume its original operating status.

Communication malfunction

When not receiving correct signal for 3 minutes, the unit has communication malfunction and the
outdoor unit stops, it is the same as normal stop when meeting the set temp.

Module protection

When module is in protection, the compressor will stop, after the compressor has stopped for 3
minutes, it will resume to running. During module protection period, the indoor unit displays
malfunction and the whole unit stops.

Connection Pipe

		27 SEER 60Hz(H/P)	4MXW2709A1000AA 4TXK2709A1P00AA	4MXW2712A1000AA 4TXK2712A1P00AA	4MXW2718A1000AA 4TXK2718A1P00AA	4MXW2724A1000AA 4TXK2724A1P00AA
		Refrigerant Charge(oz)	R410A / 45.8	R410A / 45.8	R410A / 56.4	R410A / 91.7
Connection Pipe	Length (ft)		24.6	24.6	24.6	24.6
	Gas additionalcharge(oz/ft)		0.7	0.7	1.7	1.7
	Outer Diameter	LiquidPipe(inch)	1/4"	1/4"	1/4"	1/4"
		Gas Pipe(inch)	1/2"	1/2"	5/8"	5/8"
	Max Distance	Height (ft)	49	49	65	65
		Length (ft)	98	98	131	131

Wiring Diagrams

⚠️ WARNING

Disconnect all electric power, including remote disconnects before servicing. Follow proper lockout/tagout procedures to ensure the power can not be inadvertently energized. Failure to disconnect power before servicing could result in death or serious injury.

⚠️ WARNING

Improperly installed and grounded field wiring poses FIRE & ELECTROCUTION hazards. To avoid these hazards, you MUST follow requirements for field wiring installation and grounding as described in the National Electrical Codes (NEC) and your local/state electrical codes. All field wiring MUST be performed by qualified personnel. Failure to follow these requirements could result in death or serious injury.

Figure 1. 4MXW2709A1 4MXW2712A1 4MXW2718A1 4MXW2724A1 (Heat pump indoor units)

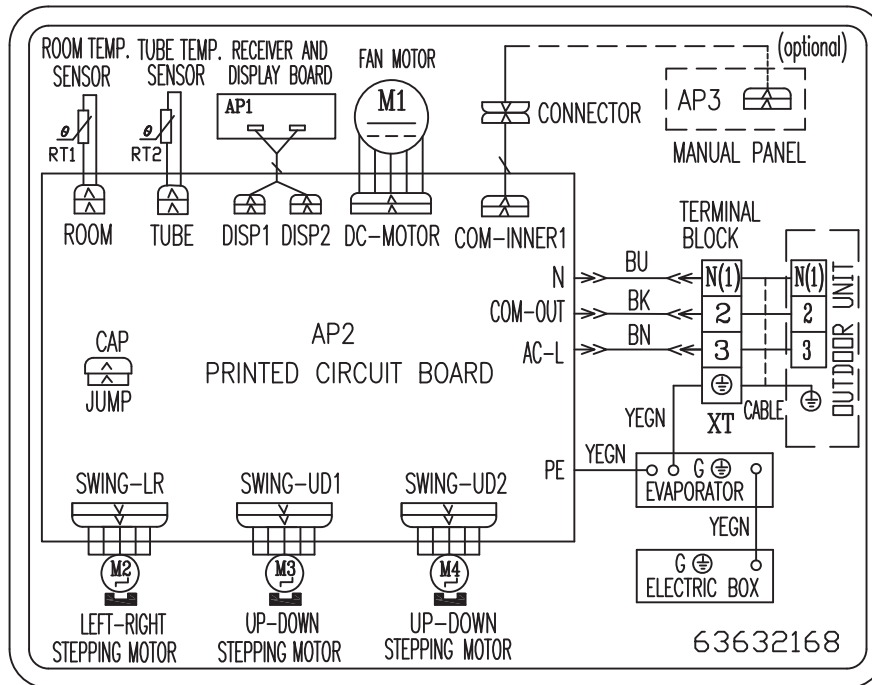

Figure 2. 4TXK2709A1 4TXK2712A1 (Heat pump outdoor units)

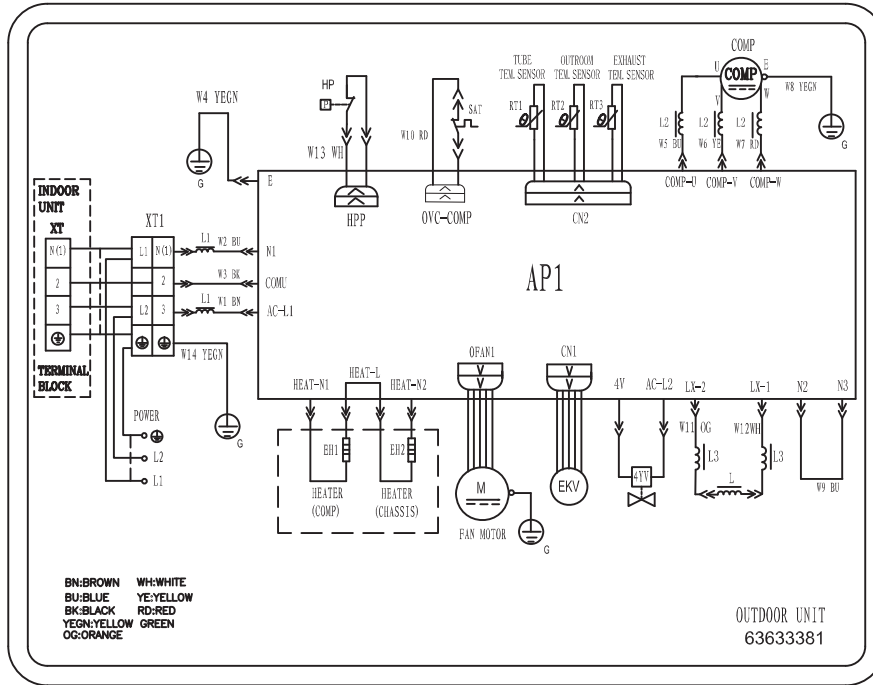

Figure 3. 4TXK2718A1 (Heat pump outdoor units)

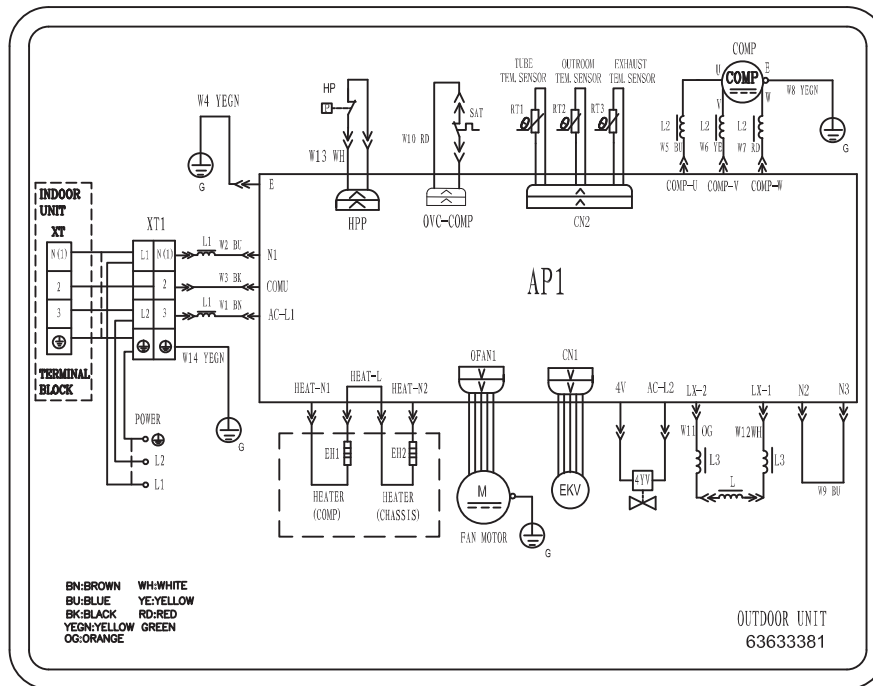
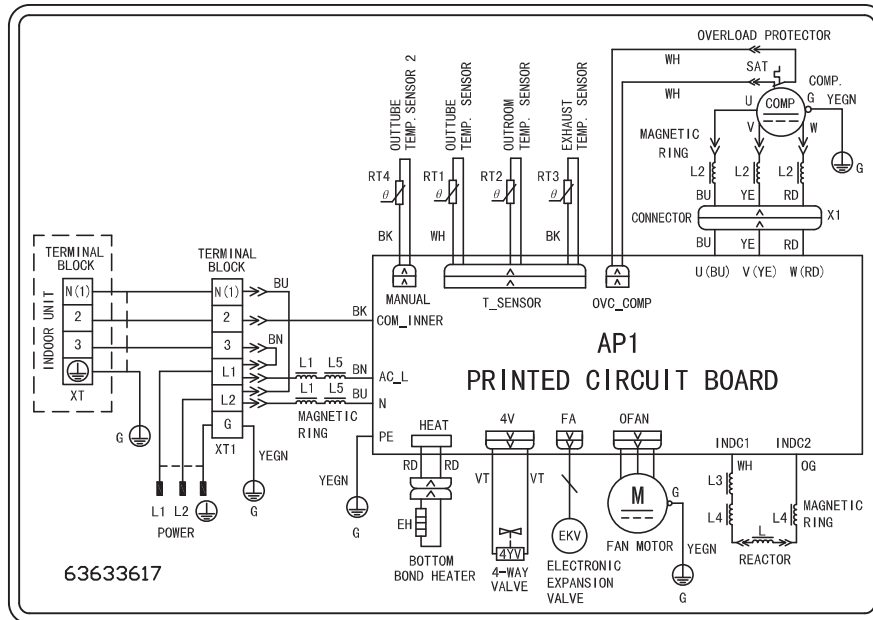

Figure 4. 4TXK2724A1 (Heat pump outdoor units)





@ 2014 IR All rights reserved.

Literature Order Number MS-SVN41A-EN

Date June 2014

Supersedes New

The manufacturer has a policy of continuous product and product data improvement and reserves the right to change design and specifications without notice.